

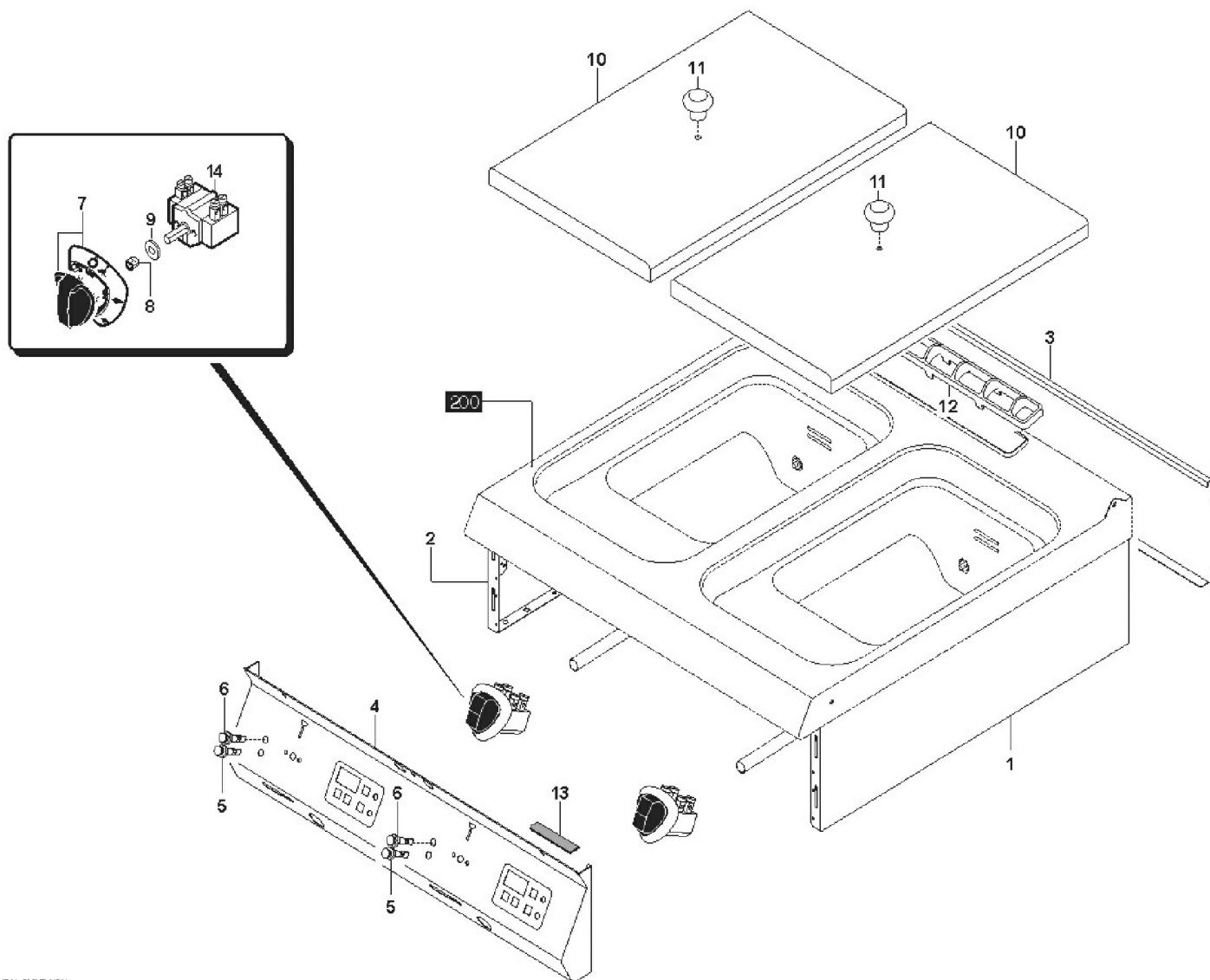





























1
HOME / COTTURA / GAMMA / 1G0FR4ED / 1



	Modifica	 ↑↓ Codice	↑↓ Descrizione	↑↓ Con	Qtà Data validità
		1 35H2490	FIANCO DX		1 01/06/2002-
		2 35H2890	FIANCO SX		1 01/06/2002-
		3 35E3370	RETRO 700 MOD.BASSI		1 01/06/2002-
		4 30A5160	CRUSCOTTO SUP. COMP.		1 01/06/2002-
		5 32W0790	LAMPADA ARANCIO 230V		2 01/06/2002-18/07/2005
		5 32W0791	LAMPADA ARANCIO 230V		2 19/07/2005-22/05/2007
		5 3106730	LAMPADA ARANCIO 230V	X	2 23/05/2007-
		6 32W1330	LAMPADA VERDE FLUOR. 230V		2 01/06/2002-18/07/2005
		6 32W1331	LAMPADA VERDE FLUOR. 230V		2 19/07/2005-22/05/2007
		6 3106710	LAMPADA VERDE 230V	X	2 23/05/2007-
		7 6300481	GRUPPO MANOPOLA EL.		1 01/06/2002-29/02/2008
		7 3015850	MANOPOLA EL.		1 01/03/2008-11/03/2008
		7 3015851	MANOPOLA EL.	X	1 12/03/2008-
		8 3170290	F/MANOPOLA	X	1 01/06/2002-
		9 3152240	PROTEZIONE TERMOSTATO	X	1 01/06/2002-
		10 35G9910	COPERCHIO VASCA		2 01/06/2002-16/07/2007
		10 35L0050	COPERCHIO VASCA	X	2 17/07/2007-
		11 36M5430	MANIGLIA	X	2 01/06/2002-
		12 36C4800	MASCHERINA SCAR. FUMI		1 01/06/2002-
		13 137AA04	GUARNIZIONE AERSTOP		7 1 01/06/2002-

1
[HOME](#) / [COTTURA](#) / [GAMMA](#) / [1G0FR4ED](#) / 1

	Modifica	   Codice	  Descrizione	  Cons
		14 32W0490	INTERRUTTORE BIPOLARE	X
		200 M012390	M.FRIG. EL. 700 GAMMA	

Qtà	Data validità
	201/06/2002-
	101/06/2002-